

iSpot Hotel 1 - DIMM

Corps: en aluminium moulé sous pression
 Réflecteur : polycarbonate métallisé haute performance.
 Normes: produit conforme aux normes EN60598 - CEI 34-21 et ayant un indice de protection IP44IK07 selon les normes EN60529.
 Groupe de risque photobiologique : Groupe 0 (exempt de risque).
 Facteur de puissance: $\geq 0,9$
 Maintien du flux lumineux à 80%: 50.000h (L80B20).

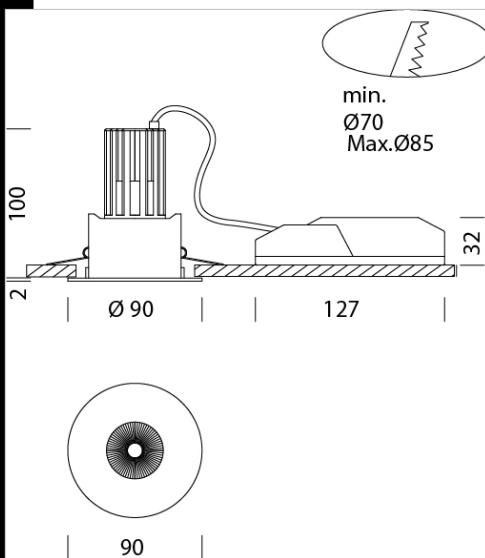

Code	Gear	Kg	Lumen Output-K-CRI	WTot	Colour
22067710-00	CLD CELL-DI	0,42	LED COB-413lm-3000K-15°-CRI 92	10 W	BIANCO
22067711-00	CLD CELL-DI	0,43	LED COB-478lm-4000K-15°-CRI 92	10 W	BIANCO
22067710-1241	CLD CELL-D-D	0,45	LED COB-413lm-3000K-15°-CRI 92	10 W	BIANCO
22067711-1241	CLD CELL-D-D	0,45	LED COB-478lm-4000K-15°-CRI 92	10 W	BIANCO



Download

DXF 2D
 - ispothotel1.dxf

The reported luminous flux is the flux emitted by the light source with a tolerance of $\pm 10\%$ compared to the indicated value. The W tot column indicates the total wattage absorbed by the system without exceeding 10% of the indicated